



UNIVERSITY OF CAMBRIDGE INTERNATIONAL EXAMINATIONS  
General Certificate of Education  
Advanced Subsidiary Level and Advanced Level

**BIOLOGY**

**9700/12**

Paper 1 Multiple Choice

**May/June 2011**

**1 hour**

Additional Materials: Multiple Choice Answer Sheet  
Soft clean eraser  
Soft pencil (type B or HB is recommended)



**READ THESE INSTRUCTIONS FIRST**

Write in soft pencil.

Do not use staples, paper clips, highlighters, glue or correction fluid.

Write your name, Centre number and candidate number on the Answer Sheet in the spaces provided unless this has been done for you.

There are **forty** questions on this paper. Answer **all** questions. For each question there are four possible answers **A, B, C** and **D**.

Choose the **one** you consider correct and record your choice in **soft pencil** on the separate Answer Sheet.

**Read the instructions on the Answer Sheet very carefully.**

Each correct answer will score one mark. A mark will not be deducted for a wrong answer.  
Any rough working should be done in this booklet.

This document consists of **14** printed pages and **2** blank pages.



- 1 Using a stage micrometer scale, one unit of an eyepiece graticule was calculated as 0.005 mm. The diameter of a spongy mesophyll cell was counted as 3.5 units on the eyepiece graticule.

What is the estimate of the diameter of the cell?

- A** 0.18  $\mu\text{m}$       **B** 1.8  $\mu\text{m}$       **C** 18.0  $\mu\text{m}$       **D** 180  $\mu\text{m}$

- 2 Membranous sacs containing products of metabolism are formed by the endoplasmic reticulum in cells.

Where are these products used?

- A** inside and outside the cell  
**B** inside lysosomes only  
**C** inside the cell only  
**D** outside the cell only

- 3 Visking tubing is an artificial partially permeable membrane used to demonstrate diffusion. Glucose molecules can pass through the pores in the membrane which are approximately 2.4 nm in diameter.

Which of the following could pass through the pores?

- 1 bacteria  
2 haemoglobin  
3 ribosomes  
4 glycogen

- A** 2 only      **B** 1 and 3 only      **C** 2 and 4 only      **D** none of these

- 4 Which of the structures are found in photosynthetic prokaryotes?

- 1 cell surface membrane  
2 cellulose wall  
3 mesosomes  
4 ribosomes  
5 chloroplasts

- A** 1, 2, 3 and 4 only  
**B** 1, 2, 4 and 5 only  
**C** 1, 3 and 4 only  
**D** 2, 3 and 5 only

5 A human aorta has a lumen width of 2 cm.

A human red blood cell has a diameter of  $7\ \mu\text{m}$ .

How many red blood cells could be laid end to end across the diameter of the aorta lumen?

- A**  $2.9 \times 10^{-3}$       **B**  $2.9 \times 10^{-2}$       **C**  $2.9 \times 10^2$       **D**  $2.9 \times 10^3$

6 Which polysaccharides are branched and which are unbranched?

	branched	unbranched
<b>A</b>	amylose	cellulose
<b>B</b>	amylopectin	cellulose
<b>C</b>	cellulose	amylose
<b>D</b>	cellulose	amylopectin

7 Three carbohydrate molecules are shown.

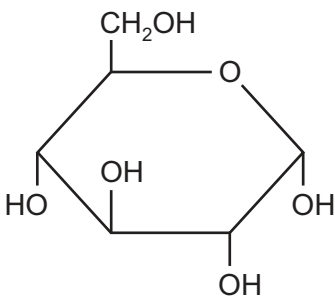

1

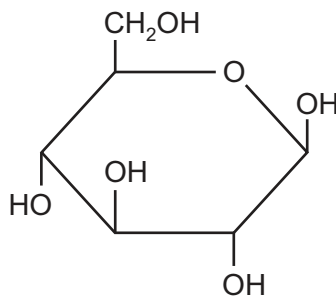

2

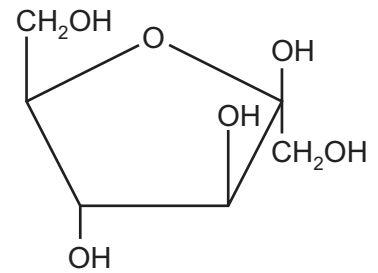

3

Which two molecules combine to form a molecule of sucrose?

- A** 1 and 2      **B** 1 and 3      **C** 2 and 3      **D** two of molecule 1

8 At which levels of protein structure do ionic bonds occur?

- 1 secondary
- 2 tertiary
- 3 quaternary

- A** 1 and 2 only      **B** 1 and 3 only      **C** 2 and 3 only      **D** 1, 2 and 3

- 9 Myoglobin is a protein with a similar function to haemoglobin. However, myoglobin does not have a quaternary structure.

Why does myoglobin **not** have a quaternary structure?

- A Myoglobin does not contain a haem group.
- B Myoglobin does not contain any alpha helices.
- C Myoglobin has a fibrous rather than a globular structure.
- D Myoglobin has only one polypeptide chain.

- 10 The diagram shows the structure of the amino acid cysteine.

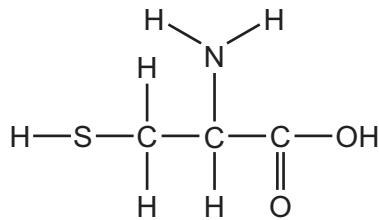

When two of these amino acids join together what bond(s) are formed?

- A disulfide bonds only
  - B disulfide and peptide bonds
  - C hydrogen, disulfide and peptide bonds
  - D peptide bonds only
- 11 Which row describes a triglyceride?

	hydrophilic	insoluble in alcohol
<b>A</b>	✓	✓
<b>B</b>	✓	x
<b>C</b>	x	✓
<b>D</b>	x	x

key

✓ = correct

x = incorrect

- 12 The graph shows the activation energy of an enzyme-catalysed reaction and the same reaction without a catalyst.

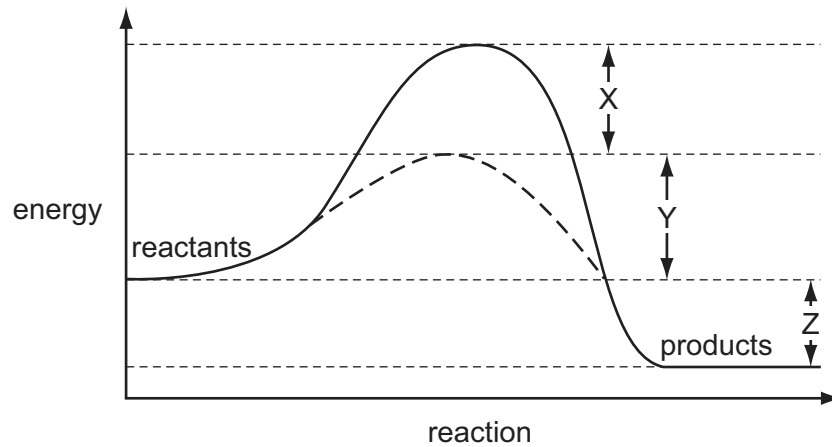

Which of the following shows the activation energy of the uncatalysed reaction?

- A**  $X + Y - Z$       **B**  $X + Z - Y$       **C**  $X + Y$       **D**  $Y + Z$

- 13 Which of the following statements are true of **all** enzymes?

- 1 soluble in water
- 2 catalyse the breakdown of large molecules into smaller molecules
- 3 only have one active site
- 4 have a quaternary structure

- A** 1, 2 and 3 only  
**B** 2, 3 and 4 only  
**C** 1 only  
**D** 4 only

14 The graphs show the effects of temperature and pH on enzyme activity.

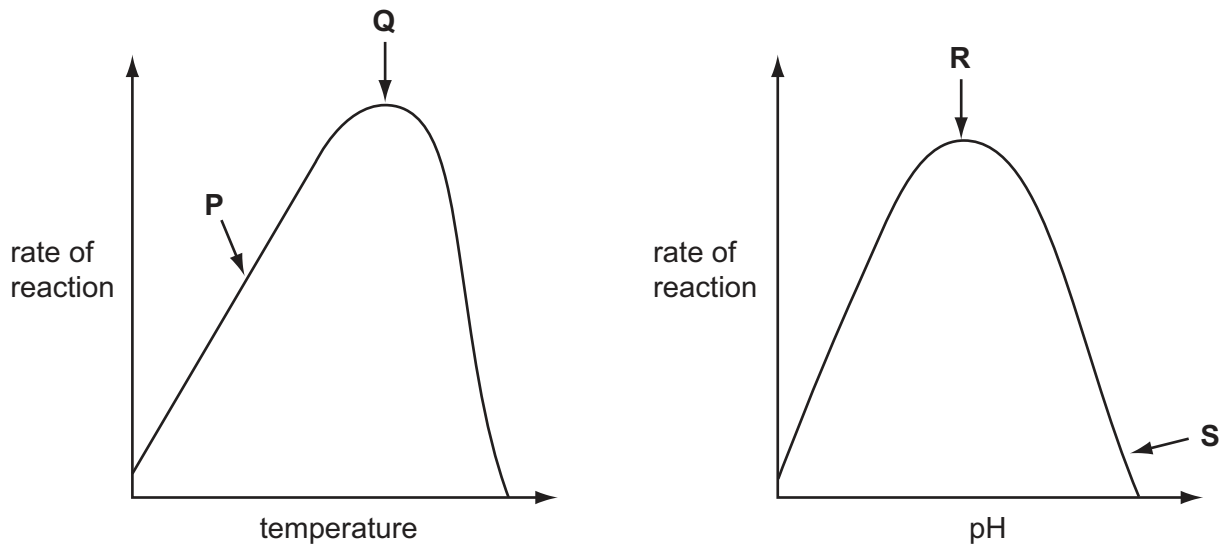

Which statement explains the enzyme activity at the point shown?

- A At P, hydrogen bonds are formed between enzyme and substrate.
- B At Q, the kinetic energy of enzyme and substrate is highest.
- C At R, peptide bonds in the enzyme begin to break.
- D At S, the enzyme is completely denatured.

15 The diagram shows part of a cell surface membrane.

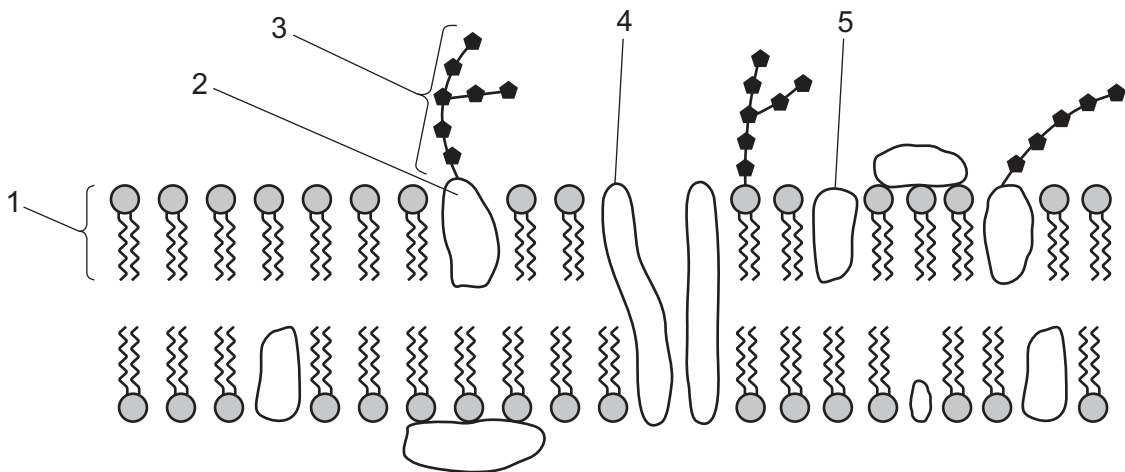

Which molecules have both hydrophobic and hydrophilic regions?

- A 1 and 5 only
- B 1, 3 and 5 only
- C 1, 2, 4 and 5 only
- D 2, 3 and 4 only

16 Increasing which type of bond helps to increase the fluidity of the cell surface membrane?

- A C—O—C
- B C—N
- C C=C
- D hydrogen

17 When cylinders of potato tissue were immersed in a  $0.35 \text{ mol dm}^{-3}$  sucrose solution, they showed no change in mass.

What will happen when cylinders are immersed in a  $0.1 \text{ mol dm}^{-3}$  sucrose solution?

- A The pressure potential of the cells will become more positive.
- B The solute potential of the cell will become more negative.
- C The water potential of the cells will become more negative.
- D The water potential of the solution will become less negative.

18 The graph represents the changes in the quantity of DNA present in one nucleus at different stages in the life cycle of a mammal.

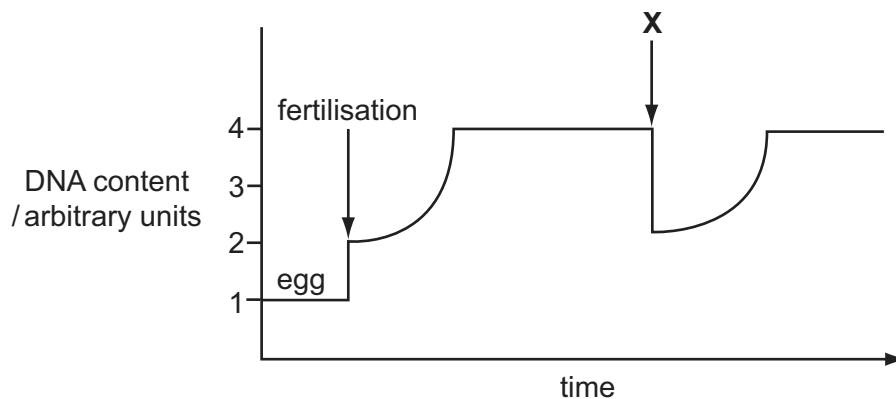

Which stage takes place at **X**?

- A interphase
- B metaphase
- C prophase
- D telophase

19 At which stage of mitosis do these events occur?

	centromeres separate	spiralisation and condensation of DNA
<b>A</b>	anaphase	interphase
<b>B</b>	anaphase	prophase
<b>C</b>	metaphase	interphase
<b>D</b>	metaphase	telophase

20 During which process does only mitosis occur?

- A** the production of antibodies from B-lymphocyte memory cells
- B** the production of cancerous tissue in alveoli
- C** the production of gametes
- D** the production of root hairs

21 The table shows the tRNA anticodons for four amino acids.

amino acid	anticodon (tRNA)
asparagine	UUA
glutamic acid	CUU
proline	GGA
threonine	UGG

A cell makes a polypeptide with the following amino acid sequence.

glutamic acid – asparagine – threonine – proline

What was the sequence of bases on the DNA from which this was formed?

- A** GGAAATACCCTT
- B** CAAAATACCCCT
- C** CTTTTATGGGGA
- D** CTTTTATCCGGA



22 What does the enzyme RNA polymerase synthesise?

- A a polypeptide from an mRNA template
- B a strand of DNA from an mRNA template
- C mRNA from a DNA template
- D mRNA from a tRNA template

23 The diagram shows part of a DNA molecule.

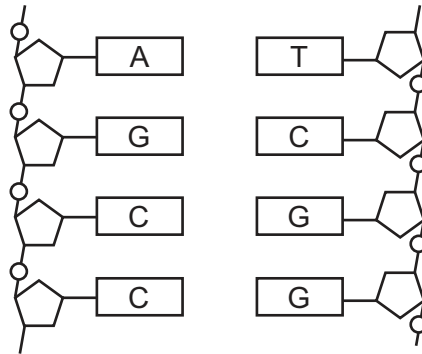

How many hydrogen bonds are involved in holding these strands of DNA together?

- A 11
  - B 9
  - C 8
  - D 4
- 24 Which features enable the aorta to withstand high pressure at ventricular systole?
- A collagen fibres and elastin fibres
  - B collagen fibres and endometrium
  - C elastin fibres and large lumen
  - D smooth muscle and small lumen
- 25 There is a decreased partial pressure of oxygen at high altitude compared to sea level.

Which row is a correct description and reason for the response of the body to high altitude?

	description	reason
<b>A</b>	more red blood cells	because haemoglobin breaks down more rapidly
<b>B</b>	red blood cells have genes switched on	so red blood cells produce more haemoglobin
<b>C</b>	oxygen dissociation curve shifts to the right	to compensate for an increase in oxygen unloading in tissues
<b>D</b>	percentage saturation of haemoglobin with oxygen in lungs decreases	so more red blood cells are produced to carry more haemoglobin

26 What events occur during contraction of the left ventricle?

- A The bicuspid valve opens and semilunar valve in the aorta opens.
- B The bicuspid valve closes and semilunar valve in the aorta closes.
- C The pressure in the left atrium becomes greater than the pressure in the left ventricle.
- D The pressure in the left ventricle becomes greater than the pressure in the aorta.

27 Blood, tissue fluid and lymph each have a different composition.

Which row shows the composition of lymph?

	contains water	contains antibodies	contains lipid	
<b>A</b>	✓	✓	✓	key ✓ = present x = absent
<b>B</b>	✓	✓	x	
<b>C</b>	✓	x	✓	
<b>D</b>	x	✓	✓	

28 Which processes are involved in transport in both phloem and xylem?

- 1 diffusion
- 2 mass flow
- 3 osmosis

- A** 1, 2 and 3
- B** 1 and 2 only
- C** 1 and 3 only
- D** 2 and 3 only

29 Which features of xerophytes are adaptations to reduce water loss by transpiration?

	rolled leaves	fleshy leaves	sunken stomata	thick waxy cuticles
<b>A</b>	✓	x	x	✓
<b>B</b>	x	✓	✓	✓
<b>C</b>	✓	✓	✓	x
<b>D</b>	✓	✓	✓	✓

key

✓ = reduces water loss

x = no effect on water loss

- 30 The graph shows the results of measuring the concentration of sucrose in the xylem, phloem and leaves of a plant during 24 hours.

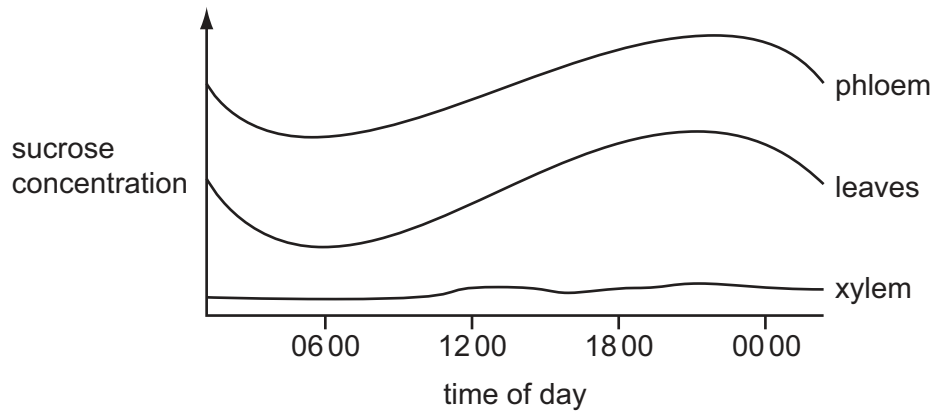

Which conclusion can be drawn from these results?

- A Osmosis moves water from the xylem to the phloem.
  - B Sucrose is actively transported into the phloem from the leaves.
  - C Sucrose is moved in both directions in the phloem.
  - D Xylem tissue uses sucrose as a source of energy.
- 31 Water that is present inside a root hair cell may leave the cell and pass to the xylem.

Through which pathway **must** the water travel?

- A apoplast
  - B plasmodesmata
  - C symplast
  - D vacuoles
- 32 What are the approximate diameters of a trachea, an alveolus, a bronchiole and a bronchus?

	trachea / mm	alveolus / mm	bronchiole / mm	bronchus / mm
A	18	0.25	0.50	12
B	18	0.50	0.25	12
C	12	0.25	0.50	18
D	12	0.50	0.25	18

33 What could occur as a result of inhaling the nicotine in tobacco smoke?

- A cilia lining the respiratory tract are paralysed, causing an increase in the secretion of mucus from enlarged goblet cells
- B diffusion into blood capillaries followed by the release of adrenaline, which increases blood pressure and heart rate
- C diffusion into the epithelial cells of the respiratory tract, increasing the risk of mutation and acting as a potential carcinogen
- D dissolves in the lining of the alveoli, causing a breakdown in the alveolar walls and a decrease in surface area for gas exchange

34 Which effects does emphysema have?

- 1 surface area to volume ratio of lungs decreases
- 2 distance of the diffusion pathway increases
- 3 volume of oxygen diffused per unit time decreases

- A 1, 2 and 3    B 1 and 2 only    C 1 and 3 only    D 2 and 3 only

35 Which of the diseases listed in the table are only treatable using antibiotics?

	cholera	measles	TB
<b>A</b>	✓	✓	✓
<b>B</b>	✓	x	✓
<b>C</b>	✓	✓	x
<b>D</b>	x	✓	✓

key  
 ✓ = treatable  
 x = not treatable

36 The diagram shows properties of diseases.

Which area of the diagram shows the properties that are common to **both** cholera and tuberculosis?

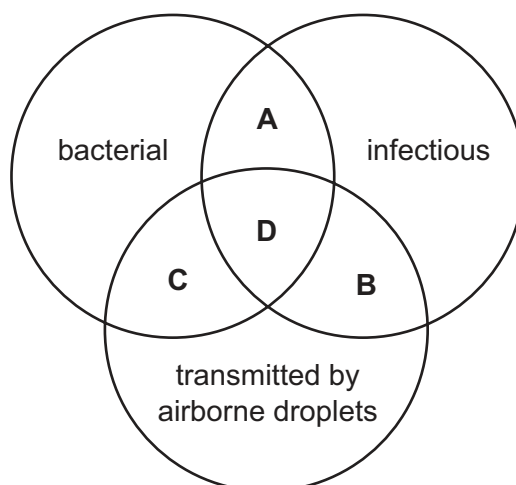

37 The disease smallpox has been eradicated by a worldwide vaccination programme.

Which set of reasons correctly identifies the problems associated with planning vaccination programmes to eradicate other diseases?

	TB	malaria	sickle cell anaemia	cholera
<b>A</b>	invade gut cells where immune system less effective	genetically inherited recessive condition	different vaccines needed for active and dormant-to-active forms	poor response with malnourished children; boosters then required
<b>B</b>	different stages with different antigens; invades body cells	poor response with malnourished children; boosters then required	genetically inherited recessive condition	different vaccines needed for active and dormant-to-active forms
<b>C</b>	different vaccines needed for active and dormant-to-active forms	different stages with different antigens; invades body cells	genetically inherited recessive condition	invade gut cells where immune system less effective
<b>D</b>	genetically inherited recessive condition	different vaccines needed for active and dormant-to-active forms	invade gut cells where immune system less effective	different stages with different antigens; invades body cells

38 Anaerobic bacteria are abundant in waterlogged soils.

Which effect does this have on soil fertility and why?

	soil fertility	reason
<b>A</b>	decreased	bacteria convert nitrate to ammonia
<b>B</b>	decreased	bacteria convert nitrate to nitrogen gas
<b>C</b>	increased	bacteria cause decomposition
<b>D</b>	increased	bacteria cause nitrogen fixation

- 39** What name is given to all the organisms in an area and their interactions with their environment?
- A** community
  - B** ecosystem
  - C** habitat
  - D** niche
- 40** What is the function of nitrifying bacteria in the soil?
- A** oxidation of ammonium compounds to nitrates
  - B** oxidation of nitrogen gas to nitrates
  - C** reduction of ammonium compounds to nitrates
  - D** reduction of nitrates to nitrites



**BLANK PAGE**

---

Permission to reproduce items where third-party owned material protected by copyright is included has been sought and cleared where possible. Every reasonable effort has been made by the publisher (UCLES) to trace copyright holders, but if any items requiring clearance have unwittingly been included, the publisher will be pleased to make amends at the earliest possible opportunity.

University of Cambridge International Examinations is part of the Cambridge Assessment Group. Cambridge Assessment is the brand name of University of Cambridge Local Examinations Syndicate (UCLES), which is itself a department of the University of Cambridge.